

C<sup>2</sup>MOS DIGITAL INTEGRATED CIRCUIT  
SILICON MONOLITHIC

# TC40H000P/F

TC40H000 QUAD 2-INPUT NAND GATE

PIN CONNECTION

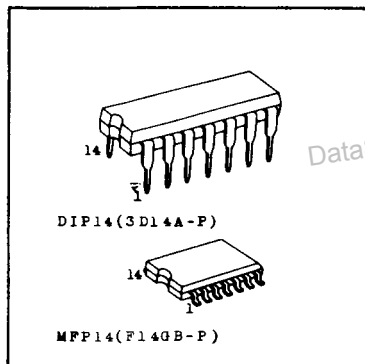
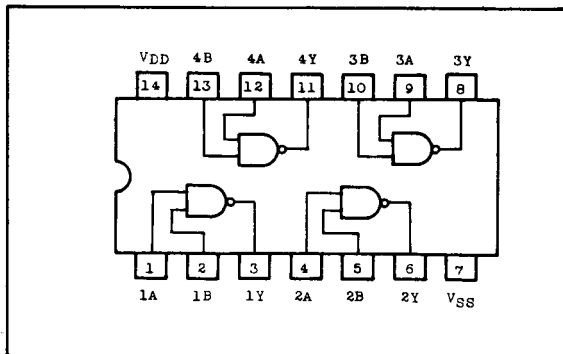

TRUTH TABLE

INPUT		OUTPUT
A	B	Y
L	L	H
H	L	H
L	H	H
H	H	L

MAXIMUM RATINGS

CHARACTERISTIC	SYMBOL	RATING	UNIT
Supply Voltage	V <sub>DD</sub>	V <sub>SS</sub> -0.5 ~ V <sub>SS</sub> +10	V
Input Voltage	V <sub>IN</sub>	V <sub>SS</sub> -0.5 ~ V <sub>DD</sub> +0.5	V
Output Voltage	V <sub>OUT</sub>	V <sub>SS</sub> -0.5 ~ V <sub>DD</sub> +0.5	V
Input Current	I <sub>IN</sub>	±10	mA
Power Dissipation	P <sub>D</sub>	300(DIP)/180(MFP)	mW
Storage Temperature	T <sub>stg</sub>	-65 ~ 150	°C
Lead Temp./Time	T <sub>sol</sub>	260°C · 10 sec	

CIRCUIT DIAGRAM

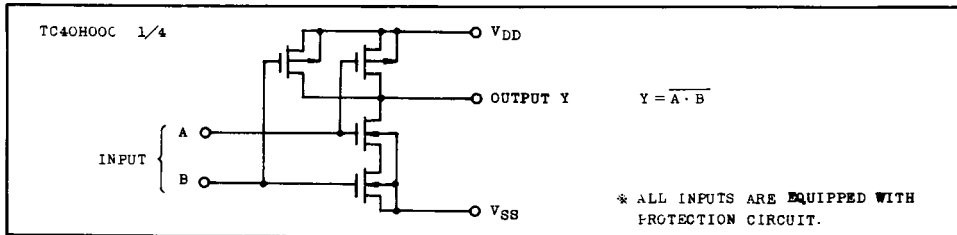

RECOMMENDED OPERATING CONDITIONS (V<sub>SS</sub>=0V)

CHARACTERISTIC	SYMBOL	TEST CONDITION	MIN.	TYP.	MAX.	UNIT
Supply Voltage	V <sub>DD</sub>	-	2.0	-	8.0	V
Input Voltage	V <sub>IN</sub>	-	0	-	V <sub>DD</sub>	V
Operating Temperature	T <sub>opr</sub>	-	-40	-	85	°C

## TC40H000P/F

ELECTRICAL CHARACTERISTICS ( $V_{SS}=0.0V$ )

CHARACTERISTIC	SYMBOL	TEST CONDITION	$V_{DD}$ (V)	-40°C		25°C			85°C		UNIT
				MIN.	MAX.	MIN.	TYP.	MAX.	MIN.	MAX.	
High Level Output Voltage	$V_{OH}$	$ I_{OUT}  < 1\mu A$ $V_{IN}=V_{SS}, V_{DD}$	5	4.95	-	4.95	5.0	-	4.95	-	V
Low Level Output Voltage	$V_{OL}$	$ I_{OUT}  < 1\mu A$ $V_{IN}=V_{DD}$	5	-	0.05	-	0.0	0.05	-	0.05	V
High Level Output Current	$I_{OH}$	$V_{OH}=4.6V$ $V_{IN}=V_{SS}, V_{DD}$	5	-0.52	-	-0.44	-	-	-0.36	-	mA
Low Level Output Current	$I_{OL}$	$V_{OL}=0.4V$ $V_{IN}=V_{DD}$	5	1.4	-	1.1	-	-	0.8	-	mA
Input Voltage	"H" Level $V_{IH}$	$ I_{OUT}  < 1\mu A$ $V_{OUT}=0.5V$ $V_{OUT}=4.5V$	5	4.0	-	4.0	-	-	4.0	-	V
	"L" Level $V_{IL}$		5	-	1.0	-	-	1.0	-	1.0	
Input Current	"H" Level $I_{IH}$	$V_{IH}=8.0V$	8	-	0.3	-	$10^{-5}$	0.3	-	1.0	$\mu A$
	"L" Level $I_{IL}$	$V_{IL}=0.0V$	8	-	-0.3	-	$-10^{-5}$	-0.3	-	-1.0	
Quiescent Supply Current	$I_{DD}$	$*V_{IN}=V_{SS}, V_{DD}$	5	-	2.0	-	$10^{-3}$	2.0	-	10.0	$\mu A$

\* All valid input combinations.

SWITCHING CHARACTERISTICS ( $T_a=25^\circ C, V_{SS}=0.0V, C_L=15pF$ )

CHARACTERISTIC		SYMBOL	TEST CONDITION	$V_{DD}$ (V)	MIN.	TYP.	MAX.	UNIT
Output Rise Time		$t_{OR}$	Circuit 1	5	-	26	40	ns
Output Fall Time		$t_{OF}$	Circuit 1	5	-	16	30	
Propagation Delay Time	(Low-High)	$t_{PLH}$	Circuit 1	5	-	18	27	ns
	(High-Low)	$t_{PHL}$		5	-	14	21	
Propagation Delay Time	(Low-High)	$t_{PLH}$	Circuit 2	5	-	13	20	ns
	(High-Low)	$t_{PHL}$		5	-	15	23	
Input Capacitance		$C_{IN}$			-	5	-	pF

## SWITCHING TIME TEST CIRCUIT

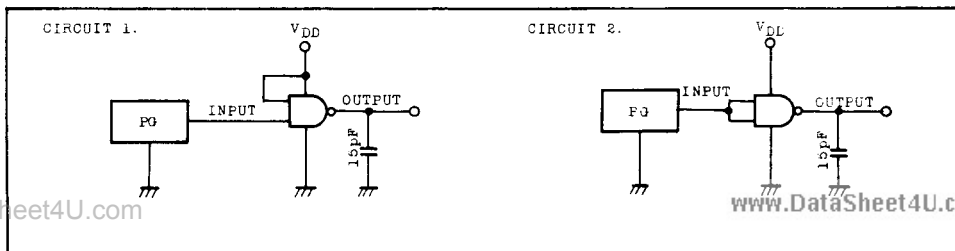

# TC40H00P/F

## SWITCHING TIME TEST WAVEFORM

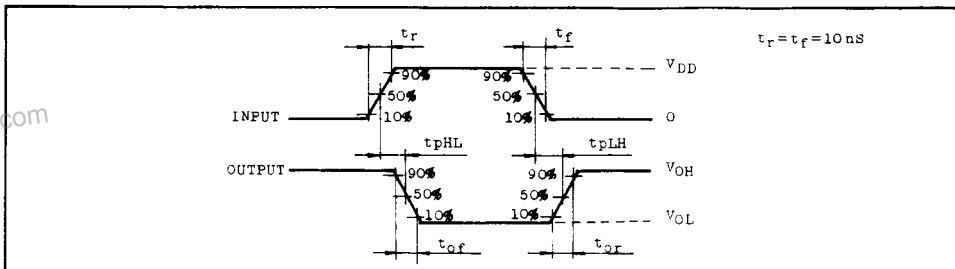

$t_{pd} - V_{DD}$

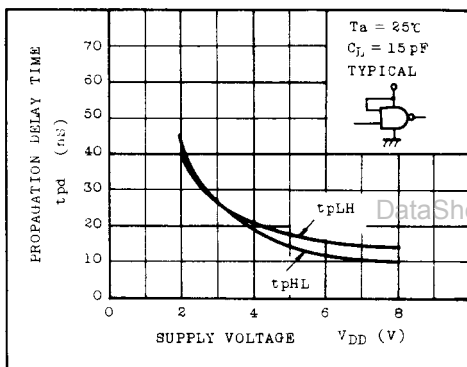

$t_{pd} - C_L$

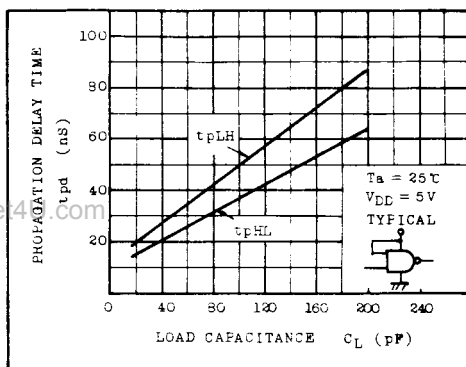

$I_{OL} - V_{OL}$

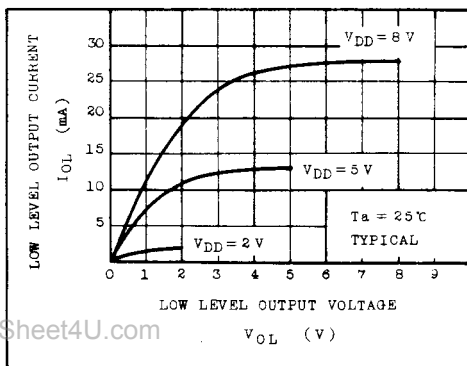

$I_{OH} - (V_{DD} - V_{OH})$

